



N° OF DOORS
x KIT



IN LINE / INLAY



INLINE / OVERLAY
with LATERAL BRACKET



MAX DOOR
WEIGHT



DOOR
THICKNESS



DOOR
MATERIAL



GAP DOOR-TRACK
GAP DOOR-FLOOR

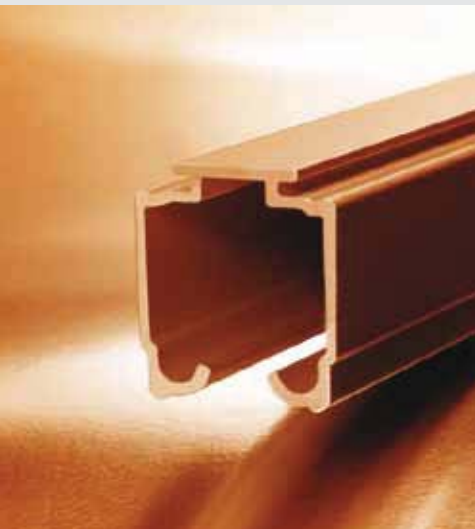

Track U21 AL



Carrier DN 80 CF



ACCESSORIES



Lateral Bracket
023BRAU21



Wide Lateral Bracket
023BRAU21W



U21 End Cap
10100910020



End Cap Fascia U21 66x8mm
10100910018



Fascia U21 66x8mm AL
041U21661 2m (6.5 ft)
041U21662 3m (9.85 ft)
041U21663 6m (19.7 ft)
041U2166-08 8 ft
041U2166-12 12 ft

DESCRIPTION

- Top sliding system for doors with weight up to 80 kg (176 lbs).
- Standard installation: Inlay

APPLICATIONS

- Ideal for access to bedrooms, offices and space divider.
- Optional lateral brackets for barn door installations.

FEATURES

- Stoppers with retention device installed inside the track will retain the door in position.
- Ball bearing high quality rollers and aluminum track allows for a silent and smooth glide.
- One box with all you need to install 1 door, just order the track and you are ready to go.
- Optional U21 Fascia will easily connect with a snap to the U21 track providing a clean, solid and elegant look.



SALINITY
TEST



ANSI-BHMA *



ROLLER

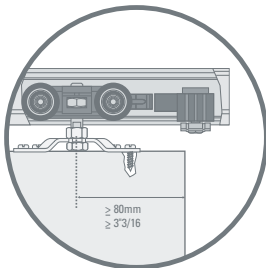
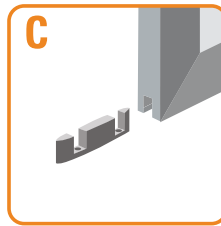
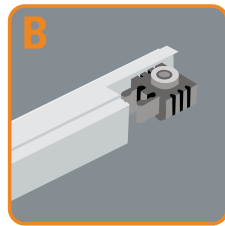
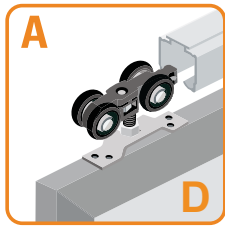
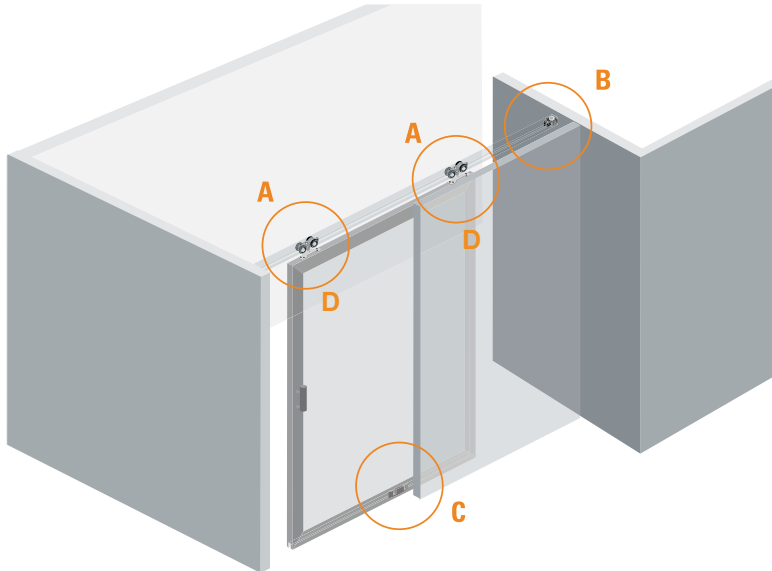

CARRIER
INSTALLATION

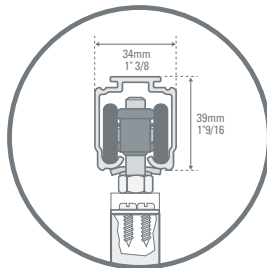

TRACK
INSTALLATION

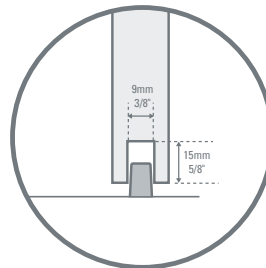

GUIDE
INSTALLATION

	Door Thickness
Track only	E ≥ 20 mm (13/16")
Track + Fascia	20mm (13/16") ≥ E ≤ 38mm (1 1/2")
Track + Bracket U21	20mm (13/16") ≥ E ≤ 30mm (1 3/16")
Track + Bracket U21W	20mm (13/16") ≥ E ≤ 45mm (1 3/4")

CARRIER TRACK



TRACK U21 AL

PART NUMBER	DESCRIPTION
• 021U211	Track U21 AL 2m (6.5 ft)
• 021U212	Track U21 AL 3m (9.85 ft)
• 021U213	Track U21 AL 6m (19.7 ft)
• 021U21-08	Track U21 AL 8 ft
• 021U21-12	Track U21 AL 12 ft

MASTER PACK: 10 units

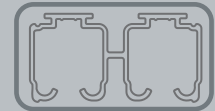

TRACK U21 DOUBLE

PART NUMBER	DESCRIPTION
• 10100603020	Track U21 Double, AL 2m (6.5 ft)
• 10100603030	Track U21 Double, AL 3m (9.85 ft)
• 10100603060	Track U21 Double, AL 6m (19.7 ft)

MASTER PACK: 3 units

**DN 80 CF,
set for 1 door**

PART NUMBER: 013203

- A** 2 Carriers DN 80
- B** 2 Stoppers with retention device
- C** 1 Floor guide GP-12
- D** 2 Mounting plate
- E** Screws

MASTER PACK: 10 sets

MASTER PACK SIZE: 8"25/32 x 7"13/32 x 7"11/64

ALL DIMENSIONS ARE IN MM., CM., KG. USA DIMENSIONS ARE APPROXIMATE

(*) Product tested using ANSI-BHMA protocol. For more information see the glossary of terms

sales@ducasseusa.com | www.ducasseusa.com